

CONNECTING ROD ORDER FORM

NAME _____ TEL

Address _____

E-mail _____

Reference Part No BOLT Engine Data Target Weight

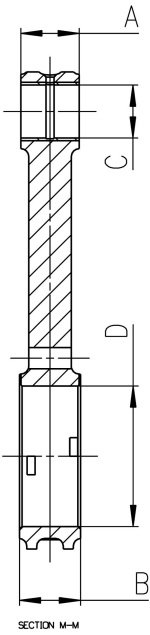
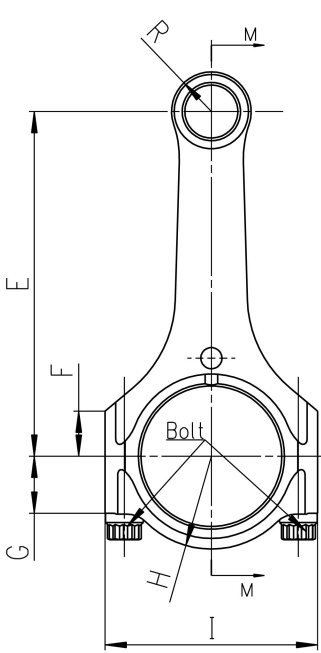

BEAM TYPE:



PPRH-Beam

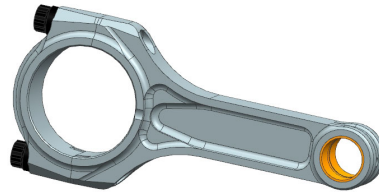

PPRI-Beam

General Dimensions

| | | |
|----------|----------------------|----|
| A | <input type="text"/> | mm |
| B | <input type="text"/> | mm |
| C | <input type="text"/> | mm |
| D | <input type="text"/> | mm |
| E | <input type="text"/> | mm |
| F | <input type="text"/> | mm |
| G | <input type="text"/> | mm |
| H | <input type="text"/> | mm |
| I | <input type="text"/> | mm |
| R | <input type="text"/> | mm |

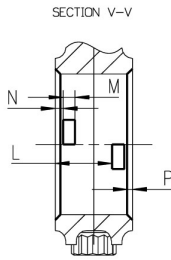
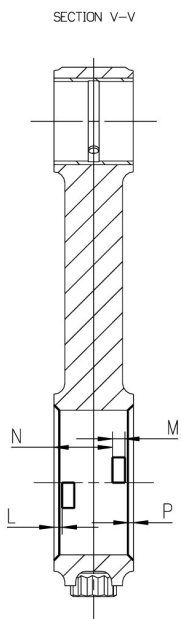
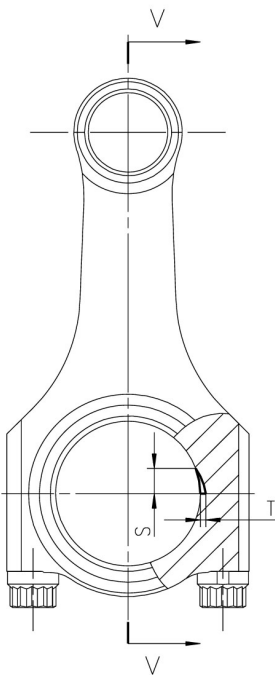

Type1

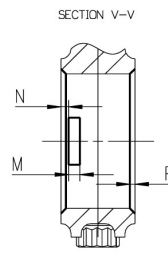

Type3

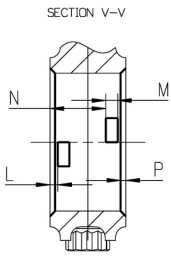

Type2

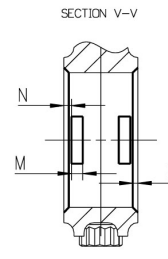

Type4

Bearing Tang

| | | |
|----------|----------------------|----|
| L | <input type="text"/> | mm |
| M | <input type="text"/> | mm |
| N | <input type="text"/> | mm |
| P | <input type="text"/> | mm |
| S | <input type="text"/> | mm |
| T | <input type="text"/> | mm |